

64*CH Hybrid NDVR

for IP and Analog Camera

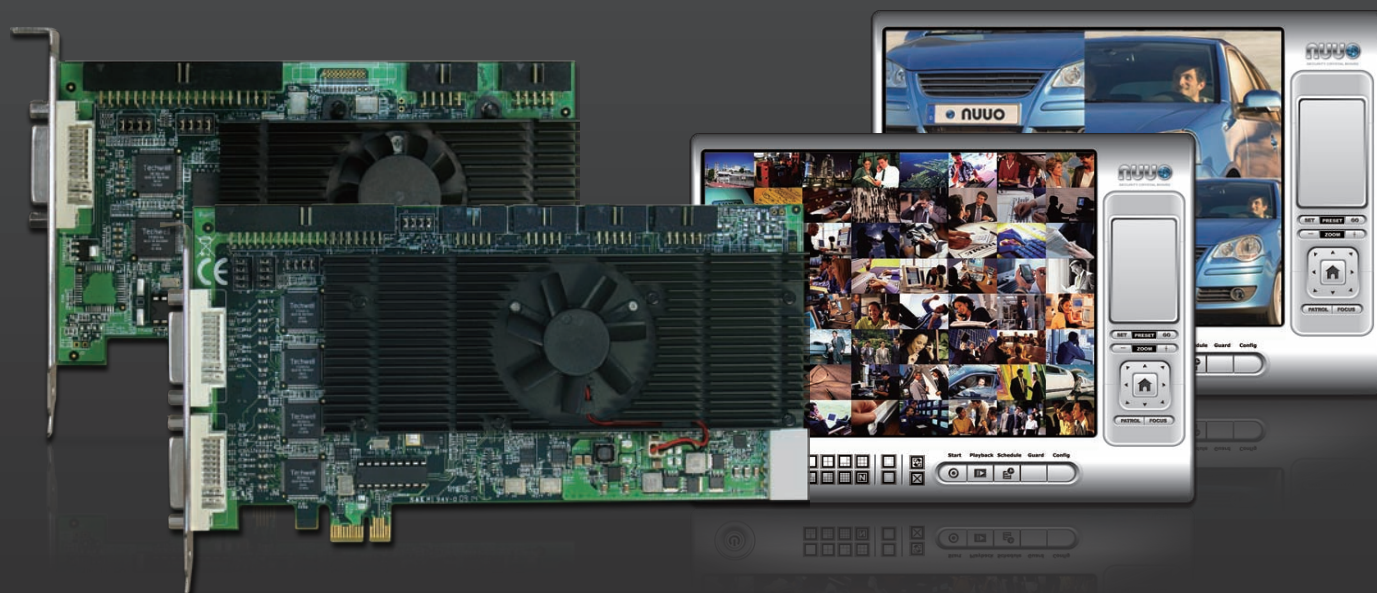

H.264 16CH D1 Real-time Recording

- Stackable Up to 32 Channels
- Supported by NUUO CMS
- Support Triple Monitors
- Up to 128 CH remote live view
- PCI-Express Interface
- Support POS
- Support 30 language
- Support Transcode

Support 36 camera brands and over 560 models



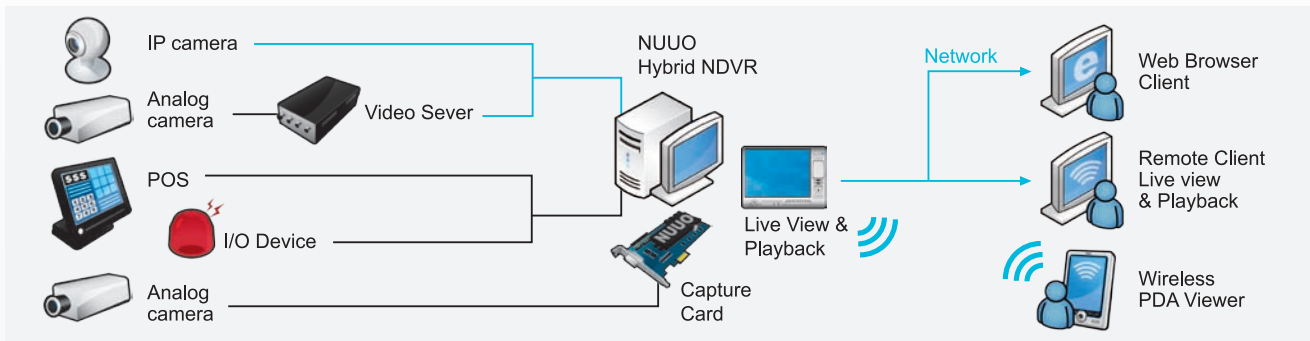

* The maximum number of camera connections depends on the server's hardware configuration and the total bit rate of the IP cameras. Please check NUUO Calculator on <http://support.nuuo.com/calculator/>



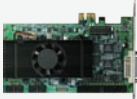
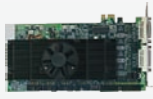

H.264 Hardware Compression Capture Card SCB 7000 Series

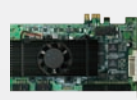
Product Name	SCB-7004	SCB-7008	SCB-7016
Video Inputs	4	8	16
Audio Inputs	4	8	16
Max. Cards Installation	4	4	2
Display Rate (NTSC/PAL)	120fps, 100fps	240fps, 200fps	480fps, 400fps
Recording Rate [D1] (NTSC/PAL)	120fps, 100fps @ D1 resolution	240fps, 200fps @ D1 resolution	480fps, 400fps @ D1 resolution
Video Resolution (NTSC)	176 x 120, 352 x 240, 704 x 480		
Video Resolution (PAL)	176 x 144, 352 x 288, 704 x 576		
Dimensions (W x H mm)	167 x 121	167 x 121	216 x 126
Product Image			

H.264 Hardware Comparison Capture Card SCB 6000 Series

Product Name	SCB-6004	SCB-6008	SCB-6016
Video Inputs	4	8	16
Audio Inputs	4	8	16
Max. Cards Installation	4	4	2
Display Rate (NTSC/PAL)	120fps, 100fps	240fps, 200fps	480fps, 400fps
Recording Rate [CIF] (NTSC/PAL)	120fps, 100fps	240fps, 200fps	480fps, 400fps
Video Resolution (NTSC)	176 x 120 ; 352 x 240; 704 x 480		
Video Resolution (PAL)	176 x 144 ; 352 x 288 ; 704 x 576		
Dimensions (W x H mm)	167 x 121	167 x 121	216 x 126
Product Image	 *Recording 30/25 fps @ D1 resolution	 *Recording 60/50 fps @ D1 resolution	 *Recording 120/100 fps @ D1 resolution

H.264 Hardware Compression Capture Card SCB 5000 Series

Product Name	SCB-5004	SCB-5008	SCB-5016
Video Inputs	4	8	16
Audio Inputs	4	8	16
Max. Cards Installation	4	4	4**
Display Rate (NTSC/PAL)	120fps, 100fps	240fps, 200fps	480fps, 400fps
Recording Rate [CIF] (NTSC/PAL)	120fps, 100fps *	240fps, 200fps *	480fps, 400fps *
Video Resolution (NTSC)	176 x 120 , 352 x 240, 528 x 320, 704 x 480		
Video Resolution (PAL)	176 x 144 , 352 x 240, 528 x 320, 704 x 480		
Dimensions (W x H mm)	154 x 95	201 x 109	265 x 125
Product Image	 * supports 1 ch @ D1 resolution	 * supports 2ch @ D1 resolution	 * supports 4ch @ D1 resolution

** The maximum number of camera connections depends on the server's hardware configuration and the total bit rate of the IP cameras. Please check NUUO Calculator on <http://support.nuuo.com/calculator/>